



MANUAL: Deluge Nozzles With Automatic Pressure Control

MASTERSTREAM NOZZLE SERIES INSTRUCTIONS FOR SAFE OPERATION AND MAINTENANCE

This instruction manual is intended to familiarize firefighters and maintenance personnel with the operation, servicing and safety procedures associated with the Masterstream Series firefighting nozzles.

This manual should be kept available to all operating and maintenance personnel.



WARNING Read instruction manual before use. Operation of this device without understanding the manual and receiving proper training is a misuse of this equipment. A person who has not read and understood all operating and safety instructions is not qualified to operate any of the Masterstream Series Nozzles.

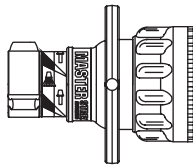

MASTERSTREAM 1000

150 - 1000 GPM @ 100 PSI
600 - 4000 LPM @ 7 BAR (700 KPA)

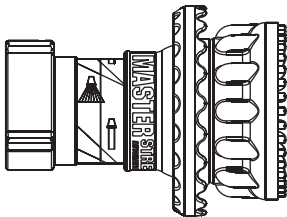

MASTERSTREAM 1250

300 - 1250 GPM @ 70 - 120 PSI
1100 - 4700 LPM @ 4.8 - 8.3 BAR (480 - 830 KPA)

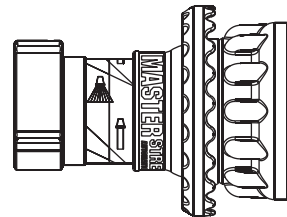

MASTERSTREAM 1500

300 - 1500 GPM @ 70 - 120 PSI
1100 - 5700 LPM @ 4.8 - 8.3 BAR (480 - 830 KPA)

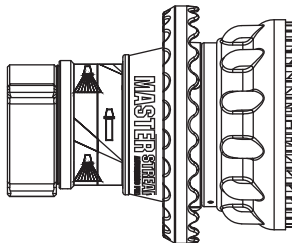

MASTERSTREAM 2000

300 - 2000 GPM @ 80 - 120 PSI
1100 - 7600 LPM @ 5.3 - 8.3 BAR (550 - 830 KPA)

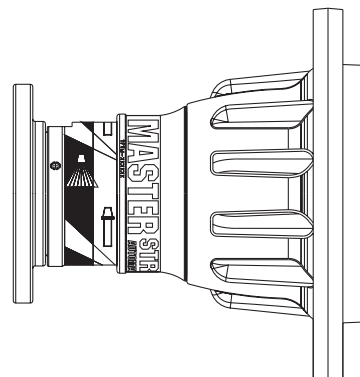

MASTERSTREAM 4000

600 - 4000 GPM @ 80 - 120 PSI
2300 - 15000 LPM @ 5.5 - 8.3 BAR (550 - 830 KPA)

TASK FORCE TIPS, Inc.
MADE IN USA • www.tft.com

2800 E. Evans Ave, Valparaiso, IN 46383-6940 USA
800-348-2686 • 219-462-6161 • Fax 219-464-7155

DANGER

PERSONAL RESPONSIBILITY CODE

The member companies of FEMSA that provide emergency response equipment and services want responders to know and understand the following:

1. Firefighting and Emergency Response are inherently dangerous activities requiring proper training in their hazards and the use of extreme caution at all times.
2. It is your responsibility to read and understand any user's instructions, including purpose and limitations, provided with any piece of equipment you may be called upon to use.
3. It is your responsibility to know that you have been properly trained in Firefighting and /or Emergency Response and in the use, precautions, and care of any equipment you may be called upon to use.
4. It is your responsibility to be in proper physical condition and to maintain the personal skill level required to operate any equipment you may be called upon to use.
5. It is your responsibility to know that your equipment is in operable condition and has been maintained in accordance with the manufacturer's instructions.
6. Failure to follow these guidelines may result in death, burns or other severe injury.



Fire and Emergency Manufacturers and Services Association, Inc.
P.O. Box 147, Lynnfield, MA 01940 • www.FEMSA.org

TABLE OF CONTENTS

1.0 MEANING OF SIGNAL WORDS	3.0 AUTOMATIC NOZZLE OPERATION
2.0 GENERAL INFORMATION	3.1 FLOW CHARACTERISTICS OF MASTERSTREAM 1000
2.1 USE WITH SALT WATER	3.2 FLOW CHARACTERISTICS OF MASTERSTREAM 1250, 1500, 2000 & MASTERSTREAM 4000
2.2 VARIOUS MODELS AND TERMS	3.3 DETERMINING FLOW WITH PRE-PIPED MONITORS
2.3 HYDRAULIC INSTALLATION	3.4 STREAM TRAJECTORY DATA
2.4 ELECTRIC INSTALLATION	4.0 FLUSHING DEBRIS
2.5 PATTERN CONTROL	5.0 MAINTENANCE
2.6 USE WITH FOAM	6.0 WARRANTY
2.6.1 FOAMJET LX WITH MASTERSTREAM 1000 NOZZLE	

1.0 MEANING OF SIGNAL WORDS

A safety related message is identified by a safety alert symbol and a signal word to indicate the level of risk involved with a particular hazard. Per ANSI standard Z535.4-1998 the definitions of the three signal words are as follows:

DANGER

DANGER indicates an imminently hazardous situation which, if not avoided, will result in death or serious injury.

WARNING

WARNING indicates a potentially hazardous situation which, if not avoided, could result in death or serious injury.

CAUTION

CAUTION indicates a potentially hazardous situation which, if not avoided, may result in minor or moderate injury.

2.0 GENERAL INFORMATION

The Task Force Tips Masterstream Series Nozzles are automatic pressure control deluge nozzles. These automatic nozzles operate by sensing the pressure at the nozzle's inlet and adjusting the discharge opening to maintain a constant pressure throughout the flow range of the nozzle. While flowing, the stream pattern can be varied from wide fog to straight stream. Trapped debris can be removed without the use of tools.

These nozzles are constructed of hardcoat anodized aluminum and UV resistant rubber. Their rugged construction is compatible with the use of fresh water as well as firefighting foam solutions. A summary of each nozzle's characteristics is shown in the table below.

SERIES	FLOW (GPM)	FLOW (LPM)	PRESSURE (PSI)	PRESSURE (BAR, KPA/100)	COUPLING SIZE
MASTERSTREAM 1000	150-1000	600-4000	100	7	2.5" NH FEMALE
MASTERSTREAM 1250	300-1250	1100-4700	70-120	4.8-8.3	2.5" NH FEMALE or 3.5" NH FEMALE
MASTERSTREAM 1500	300-1500	1100-5700	70-120	4.8-8.3	2.5 NH FEMALE or 3.5" NH FEMALE
MASTERSTREAM 2000	300-2000	1100-7600	80-120	5.5-8.3	3.5" NH FEMALE
MASTERSTREAM 4000	600-4000	2300-15000	80-120	5.5-8.3	6" ANSI 150 FLANGE

NOTES ON ABOVE TABLE:

- Other threads, coupling sizes or connector styles can be specified at time of order.
- Masterstream 1000 nozzle is also available in selectable gallonage or fixed orifice models. See catalog for details.
- Masterstream 1250, 1500, 2000 and 4000 nozzles are field adjustable within the range of pressures shown.
- For long term installations, it is recommended that the threads be greased before installing the nozzle.

OPERATING NOTE ABOUT AUTOMATIC NOZZLES: The automatic nozzle is considerably different than "conventional" nozzles because of basic changes in the operating principle. These differences not only assure the most effective operation under a variety of conditions, but will also utilize the available water supply most efficiently. It is important that nozzle operators, pump operators, and officers be fully aware of these differences. Therefore, proper instruction is required for safe and effective operations.

WARNING This equipment is intended for use by trained personnel for firefighting. Their use for other purposes may involve hazards not addressed by this manual. Seek appropriate guidance and training to reduce risk of injury.

CAUTION Nozzle must be properly connected. Mismatched or damaged threads may cause nozzle to leak or uncouple under pressure and could cause injury.

CAUTION Do not couple aluminum to brass. Dissimilar metals coupled together can cause galvanic corrosion that can result in inability to unscrew threads or complete loss of thread engagement.

WARNING Injury can occur from an inadequately supported nozzle. The mounting must be capable of supporting the nozzle reaction force which can be in excess of 2300 lbs (4000 GPM at 120 PSI).

WARNING Some volatile liquids can be ignited by static discharge. Static build-up can occur from:

- Electrochemical separation of charge as water drains through low conductivity, refined products.
- Applying foam over a low conductivity liquid of sufficient depth to retain the charge created as the foam blanket drains.
- Streaming currents as water or foam is introduced into the storage tank.¹

WARNING Water is a conductor of electricity. Application of water solutions on high voltage equipment can cause injury or death by electrocution. The amount of current that may be carried back to the nozzle will depend on the following factors:

- Voltage of the line or equipment
- Distance from the nozzle to the line or equipment
- Size of the stream
- Whether the stream is solid or broken
- Purity of the water²

¹ Electrostatic Hazards of Foam Blanketing Operations by Peter Howels. Industrial Fire Safety July/August 1993

² The Fire Fighter and Electrical Equipment, The University of Michigan Extension Service, Fourth Printing 1983. Page 47.

2.1 USE WITH SALT WATER

Use with salt water is permissible provided nozzle is thoroughly cleaned with fresh water after each use. The service life of the nozzle may be shortened due to the effects of corrosion and is not covered under warranty.

2.2 VARIOUS MODELS AND TERMS

The spray pattern is changed from wide fog to straight stream by means of the "stream shaper". Models are available with five different methods to move the stream shaper as shown in figures 1A - 1E. See catalog for model numbers and details.

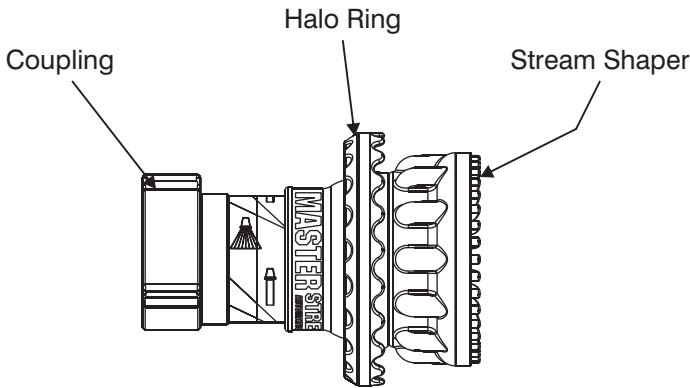

Fig 1A Stream Shaper moved manually by rotating "halo ring"

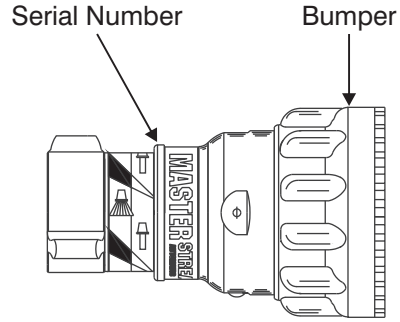

Fig 1B Stream Shaper moved manually by rotating "bumper"

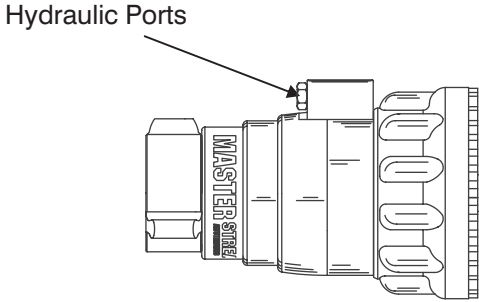
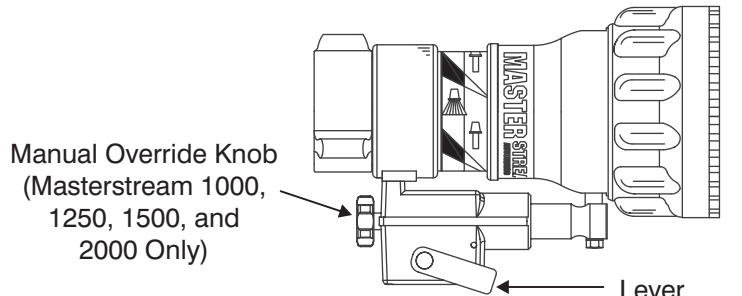

Fig 1C Stream Shaper moved remotely by hydraulics



Hold lever down and turn knob for manual override.

Fig 1D Stream Shaper moved remotely by electricity (12-24 volts)

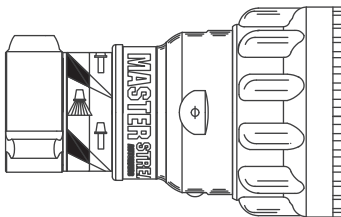

Fig 1E Stream Shaper moved by linear (push/pull) motion from user's mechanism

FIG 1 - Methods for Moving Stream Shaper

2.3 HYDRAULIC INSTALLATION

On nozzles with hydraulic stream shaper actuation, the hydraulic system is connected to the nozzle with two 1/8"-27 NPT (1/4"-18 NPT on Masterstream 4000) female ports on the filter block located on the nozzle's stream shaper. When the port on the left of the filter block (as seen from behind the nozzle) is pressurized, the shaper moves back into the wide fog position. Pressurizing the right port moves the shaper forward into straight stream. Hydraulic lines must be flexible to allow for movement of the stream shaper.

Use only clean fluid compatible with Buna N Compound (Nitrile). System must be free from all dirt, chips and contaminants. Replacement filter elements are available from TFT (item #M160). Maximum hydraulic pressure is 1000 psi (70 bar, 7000 Kpa) for Masterstream 1000 or Masterstream 2000 Nozzles. (1500 psi, 105 bar, 10500 Kpa for Masterstream 4000 Nozzle).

2.4 ELECTRIC INSTALLATION

Nozzles with electric stream shaper actuation are shipped with a wiring diagram (TFT item #LIM-040). Other documentation is available on request. The actuator is not rated as ignition proof, explosion proof, or intrinsically safe. NOTE: Masterstream 1000, 1250 1500 and 2000 nozzles are equipped with manual override in case of electrical power failure. Refer to figure 1D for manual override instructions.

⚠ WARNING The electric motor and other components are ignition sources. The electric stream shaper should be operated only in areas where there is adequate ventilation and no hazard of flammable vapor buildup.

2.5 PATTERN CONTROL

TFT's Masterstream Series nozzles have full pattern control from straight stream to wide fog. On models with manual shapers, turning the stream shaper clockwise (as seen from the operating position behind the nozzle) moves the shaper to the straight stream position. Turning the stream shaper counterclockwise will result in an increasingly wider pattern.

Since the stream trim point varies with flow, the nozzle should be "trimmed" after changing the flow to obtain the straightest and farthest reaching stream. To properly trim a stream, first open the pattern to narrow fog. Then close the stream to parallel to give maximum reach. Note: Turning the shaper further forward will cause stream crossover and reduce the effective reach of the nozzle.

2.6 USE WITH FOAM

The Masterstream Series nozzles may be used with foam solutions. Refer to fire service training for the proper use of foam.

⚠ WARNING For Class B fires, lack of foam or interruption in the foam stream can cause a break in the foam blanket and greatly increase the risk of injury or death.

Assure that application rate is sufficient (see NFPA 11 or foam manufacturer's recommendations); Enough concentrate is on hand to complete task (see NFPA for minimum duration time requirements); Foam logistics have been carefully planned.

Allow for such things as storage of foam in a location not exposed to the hazard it protects; Personnel, equipment and technique to deliver foam at a rapid enough rate; Removal of empty foam containers; Clear path to deliver foam, as hoses and other equipment and vehicles are deployed.

⚠ WARNING Improper use of foam can result in injury or damage to the environment. Follow foam manufacturer's instructions and fire service training.

Avoid using wrong type of foam on a fire, i.e. Class A foam on a Class B fire; Plunging foam into pools of burning liquid fuels; Causing environmental damage; Directing stream at personnel.

⚠ WARNING There is a wide variety of foam concentrates. Each user is responsible for verifying that any foam concentrate chosen to be used with this unit has been tested to assure that the foam obtained is suitable for the purpose intended.

2.6.1 FOAMJET LX WITH MASTERSTREAM 1000 NOZZLE

To increase the expansion ratio, Task Force Tips "Foamjet LX" (model FJ-LX-M) may be used with the Masterstream 1000 nozzle. This low expansion foam tube attaches and detaches quickly from the nozzle. Adjust nozzle spray pattern to give best foam quality. Note: As expansion ratio is increased, the reach of the nozzle will be decreased due to the greater amount of bubbles in the stream and their inability to penetrate the air. Generally the reach with foam is approximately 10% less than with water only. Actual results will vary based on brand of foam, hardness of water, temperature, etc.

3.0 AUTOMATIC NOZZLE OPERATION

Automatic nozzles operate by sensing the pressure at the nozzle's inlet and adjusting the discharge opening to maintain a constant pressure throughout the flow range of the nozzle. For example, when the pressure at the inlet increases, the exit area is automatically increased until the inlet pressure returns to the nominal pressure of the nozzle.

Note: Inlet pressure of a Masterstream Series nozzle will stabilize at the nominal pressure (within 5%). This stabilization may take as long as half a minute after a change in inlet pressure.

3.1 FLOW CHARACTERISTICS OF MASTERSTREAM 1000

Within its flow range, the Masterstream 1000 automatic nozzles operate at the nominal pressure of 100 PSI (7 BAR, 700 KPA). Figures 2 shows typical performance of this nozzle.

⚠ WARNING An inadequate supply of nozzle pressure and/or flow will cause an ineffective stream and can result in injury, death or loss of property.

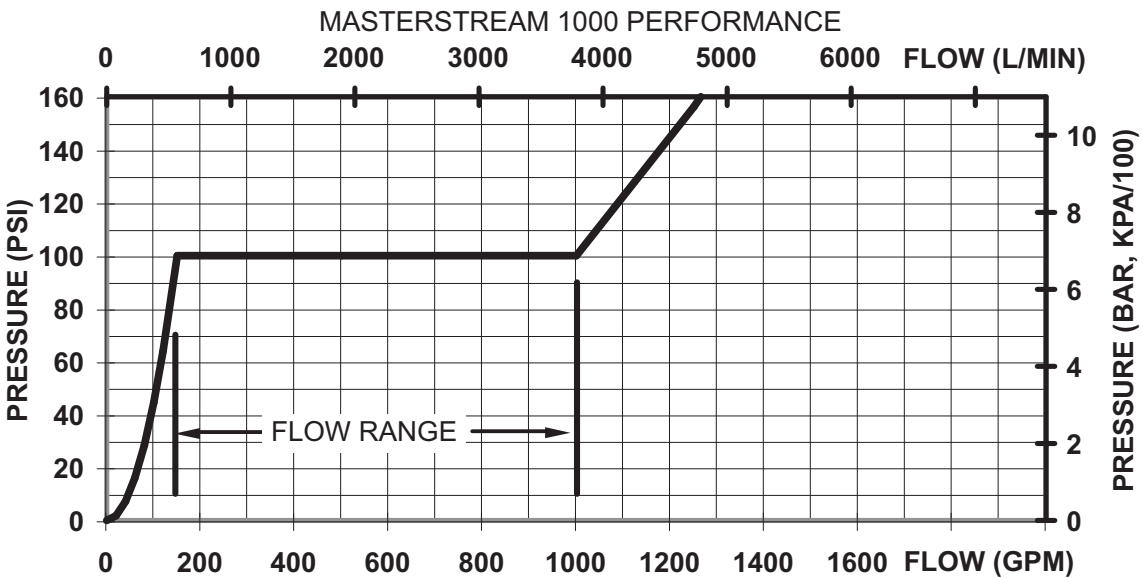

FIG 2 - Masterstream 1000 Pressure Performance

3.2 FLOW CHARACTERISTICS OF MASTERSTREAM 1250, 1500, 2000 AND 4000

The operating pressure of these nozzles is user adjustable. Pressure adjustment is performed by twisting a knob on the front of the nozzle to the desired pressure setting. Figures 3A - 3D show typical flow performance for each model when adjusted to marked pressure settings. The automatic pressure control will maintain the set pressure anywhere within the flow ranges shown on the graphs, which vary according to pressure setting.

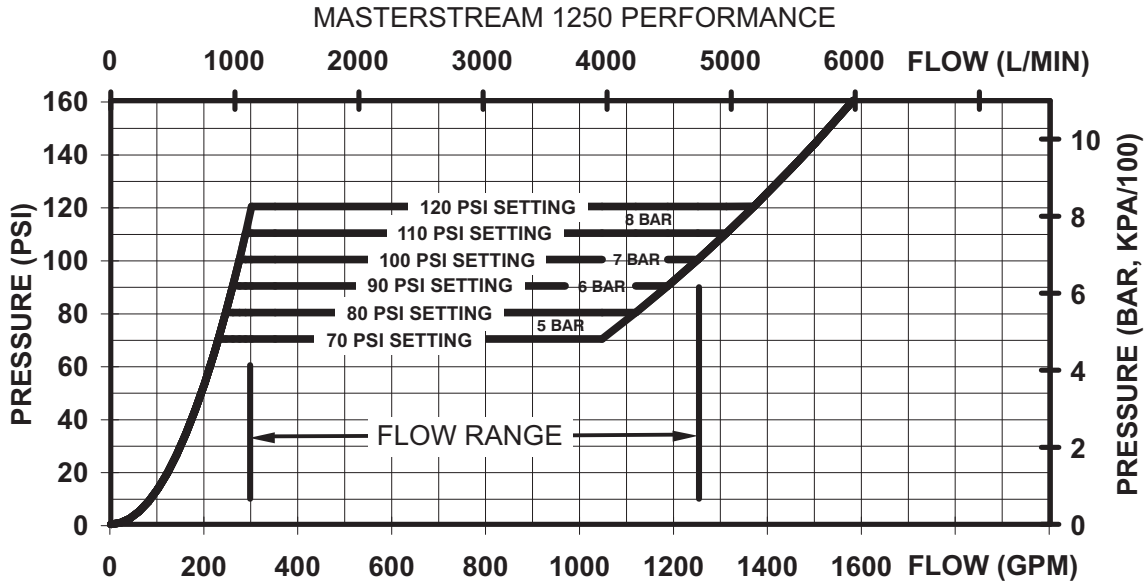
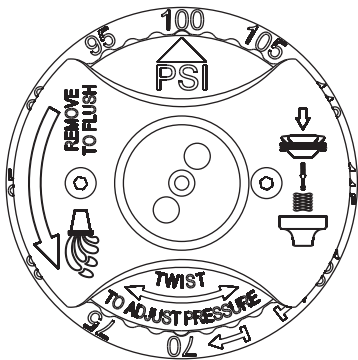

FIG 3A - Masterstream 1250 Pressure Performance



To adjust the Master 1250 and 1500, simply twist the pressure adjustment knob to the desired detent setting.

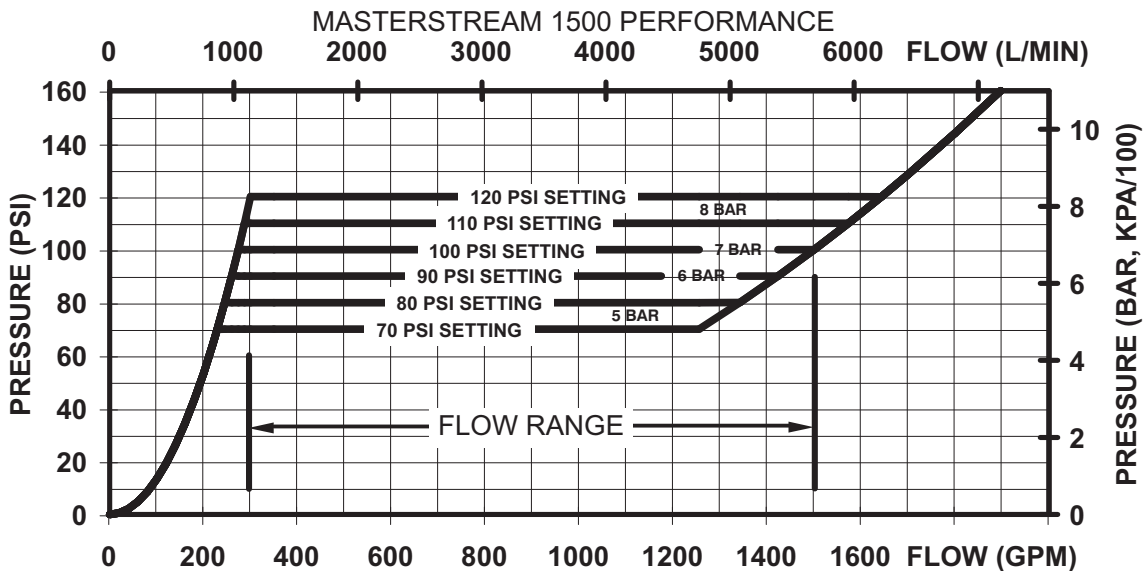

FIG 3B - Masterstream 1500 Pressure Performance

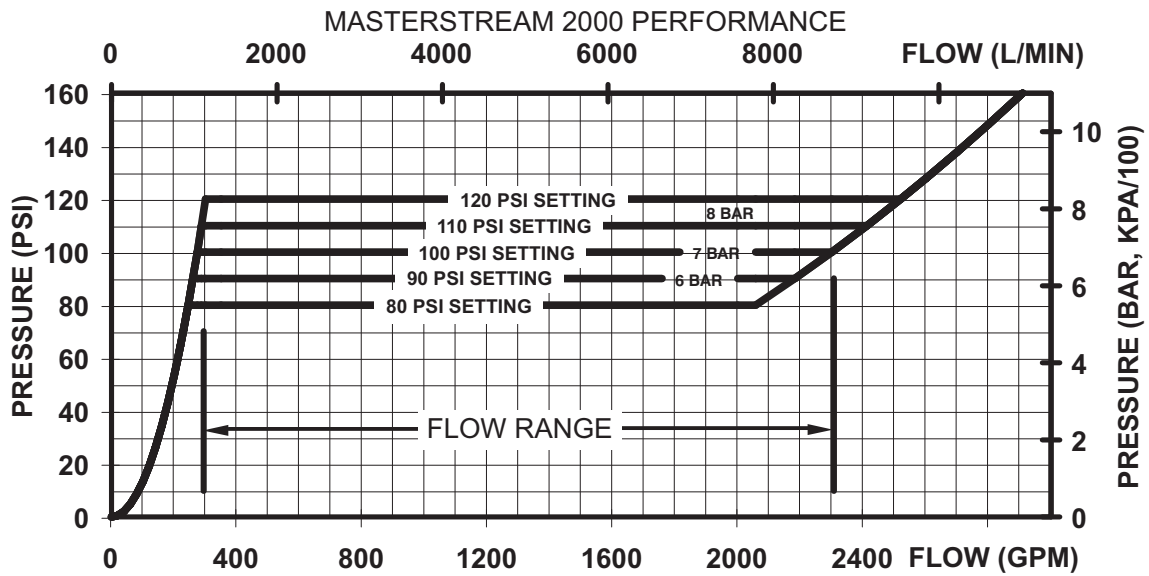
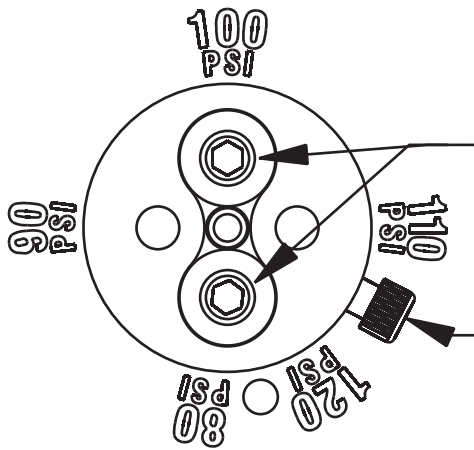

FIG 3C - Masterstream 2000 Pressure Performance



TO ADJUST PRESSURE SETTING:

1. LOOSEN BOTH SCREWS
2. ADJUST PRESSURE KNOB
3. LOCK KNOB BY TIGHTENING BOTH SCREWS UNTIL SNUG

NOTE: LOCKED KNOB SHOULD NOT ROTATE BY HAND

POINTER INDICATES OPERATING PRESSURE
IMPORTANT: DO NOT LOOSEN THIS SCREW!

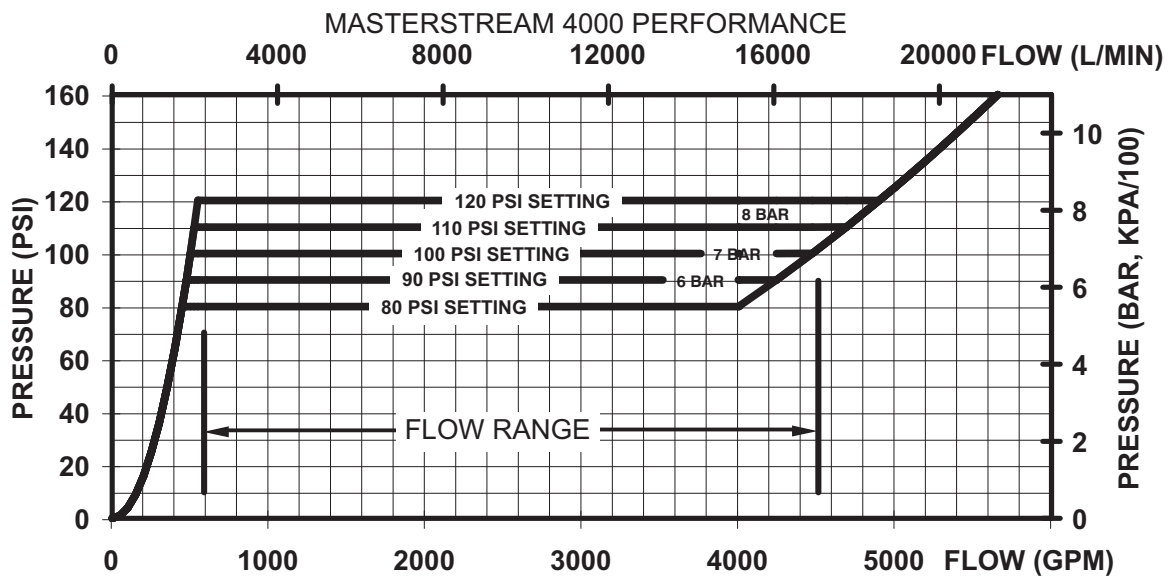

FIG 3D - Masterstream 4000 Pressure Performance

3.3 DETERMINING FLOW WITH PRE-PIPED MONITORS

The simplest procedure to determine flow with automatic nozzles is with a flow meter. If a flow meter is unavailable, then the flow may be estimated using pressure loss data between the nozzle and an in-line pressure gauge at the pump or considerably upstream from the nozzle. Data is taken with a smooth bore nozzle and handheld pitot gauge. Note: Equations assume no substantial change in elevation between in-line pressure gauge and nozzle.

Step 1: Determine flow of smooth bore nozzle.

Flow water with a smooth bore nozzle and record the nozzle's size, pitot pressure and in-line pressure gauge reading. The smooth bore nozzle's flow is calculated from the Freeman formula:

Where: $F = 29.71$ for English units (GPM, INCHES, PSI)
 $F = .667$ for metric units (LPM, MM, BAR) Note: 1 BAR=100 KPA
 Q_{smooth} flow in GPM (or LPM)
 D exit diameter in INCHES (or MM)
 P_{pitot} pitot pressure in PSI (or BAR)

$$Q_{smooth} = F \times D^2 \sqrt{P_{pitot}}$$

Step 2: Find pressure loss constant.

Using the results from step 1, use the following equation to calculate the pressure loss constant between the in-line pressure gauge and the nozzle:

Where: C piping pressure loss constant in GPM^2/PSI (or LPM^2/BAR)
 $P_{in-line}$ in-line pressure gauge reading in PSI (or BAR)

$$C = \frac{Q_{smooth}^2}{P_{in-line} - P_{pitot}}$$

Step 3: Calculate flow with automatic nozzle.

Using the pressure loss constant from step 2 and the following equation, the flow with an automatic nozzle can be calculated for your particular installation.

Where: Q_{auto} automatic nozzle flow in GPM (or LPM)
 P_{auto} nominal nozzle operating pressure in PSI (or BAR)

$$Q_{auto} = \sqrt{(P_{in-line} - P_{auto})C}$$

Mount a graph or table of the results adjacent to the in-line pressure gauge. Deliver any desired flow by adjustment of pump pressure.

3.4 STREAM TRAJECTORY DATA

Figures 4A - 4E give the stream trajectory for the Masterstream Series nozzles at various flows.

Notes on trajectory graphs:

- Graphs show approximate effective stream trajectory at 30 degrees elevation in no wind conditions. Distance to last water drops approximately 10% farther.
- To estimate trajectories at elevations other than 30 degrees, refer to document LTT-135, available at www.tft.com.
- Trajectories shown are for water. The addition of foam is expected to decrease the reach by 10%.
- Tail or head winds of 20 MPH (30 KPH) may increase or decrease the range approximately 30%.
- Stream trajectory of Masterstream 4000 based on "The Trajectories of Large Fire Fighting Jets" by A.P. Hatton and M.J. Osborne, Reference: "The International Journal of Heat and Fluid Flow", Vol 1 No 1.

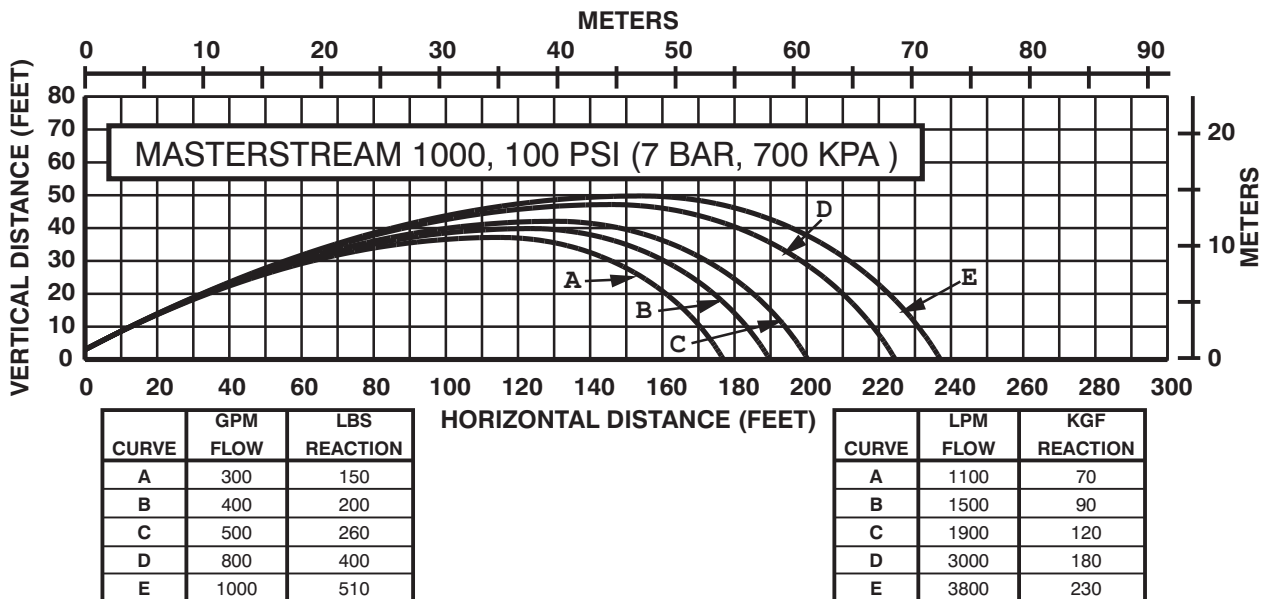

FIG 4A - Masterstream 1000 Stream Trajectory

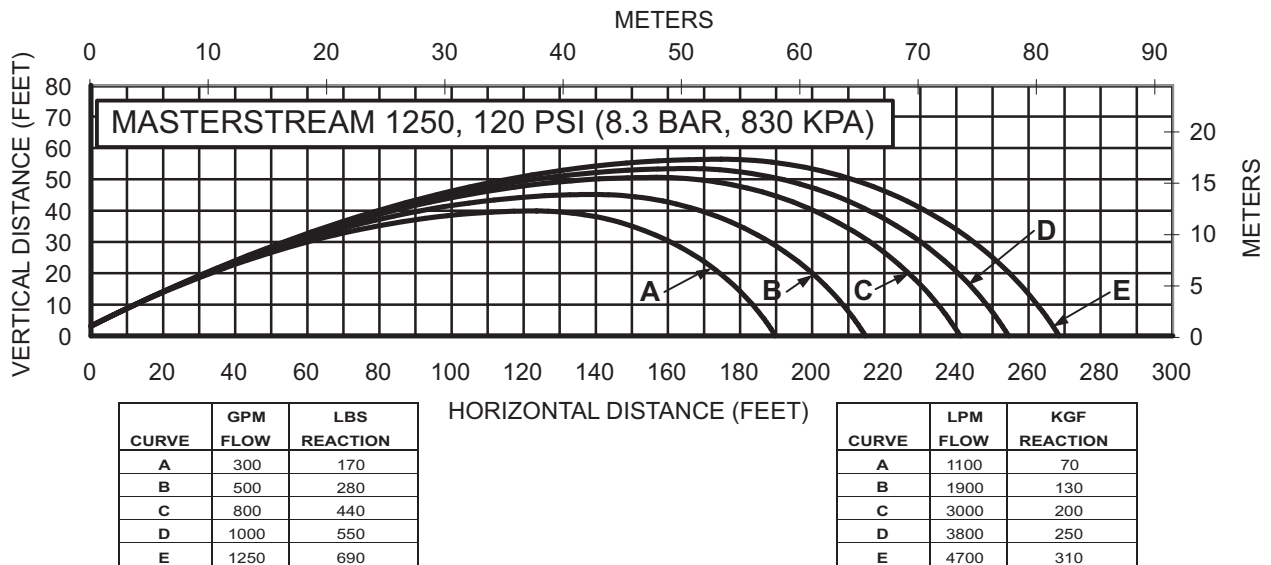
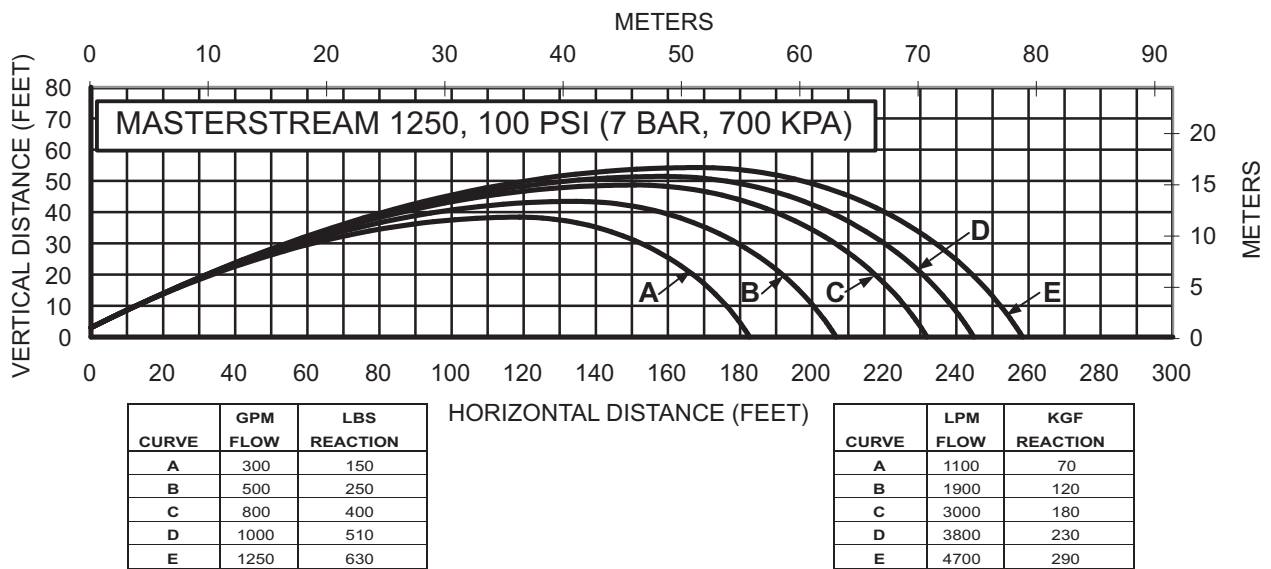
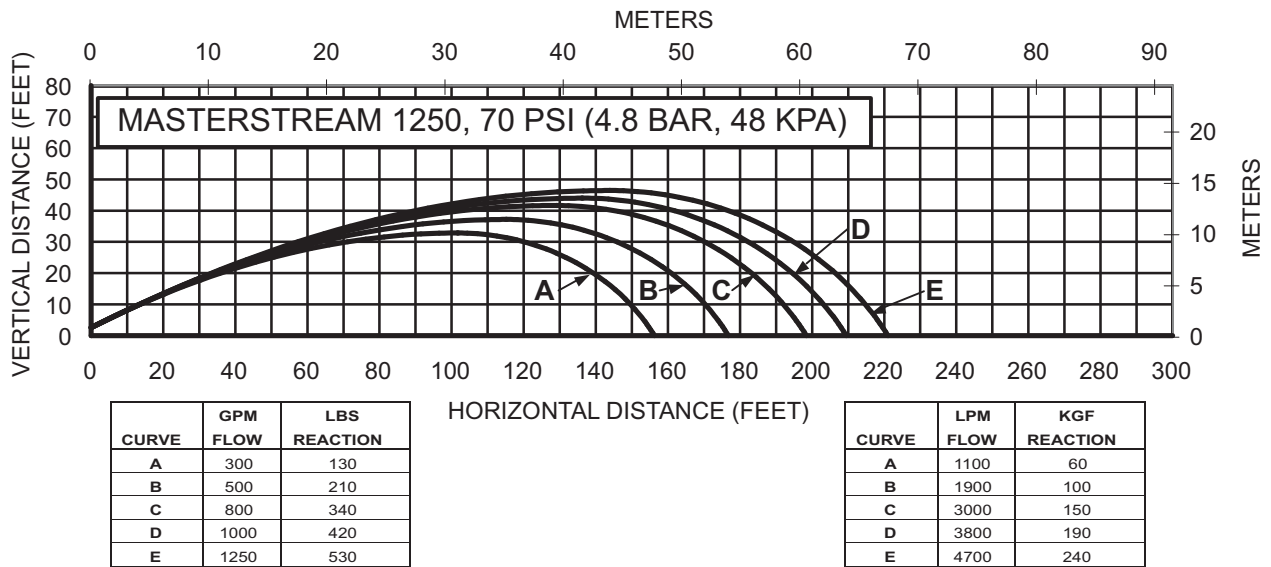

FIG 4B - Masterstream 1250 Stream Trajectory

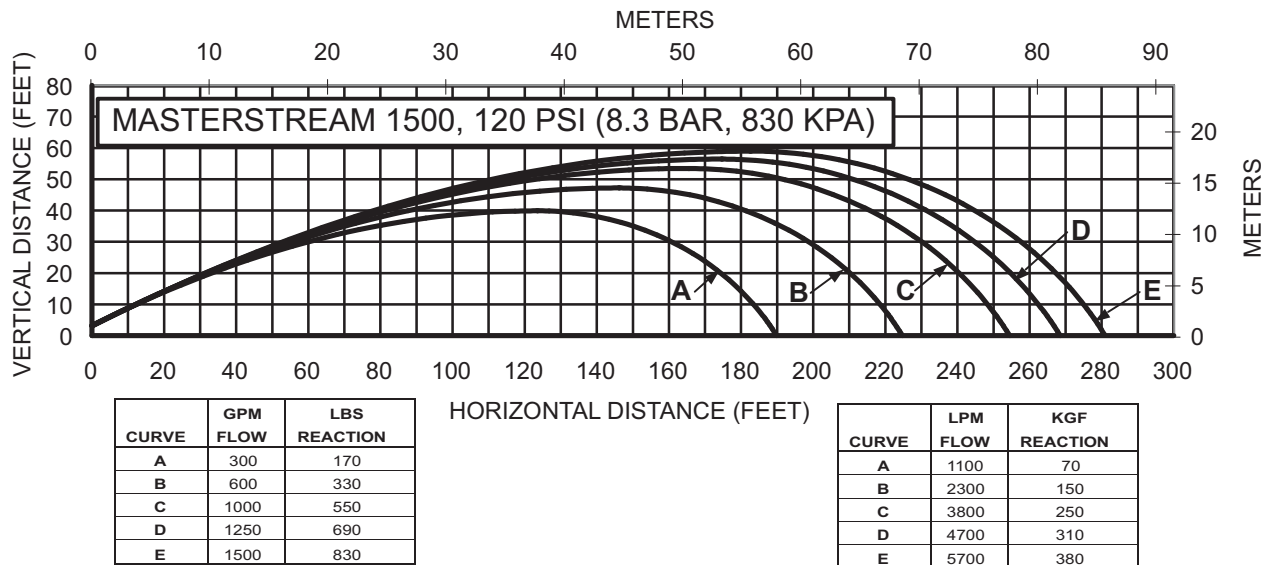
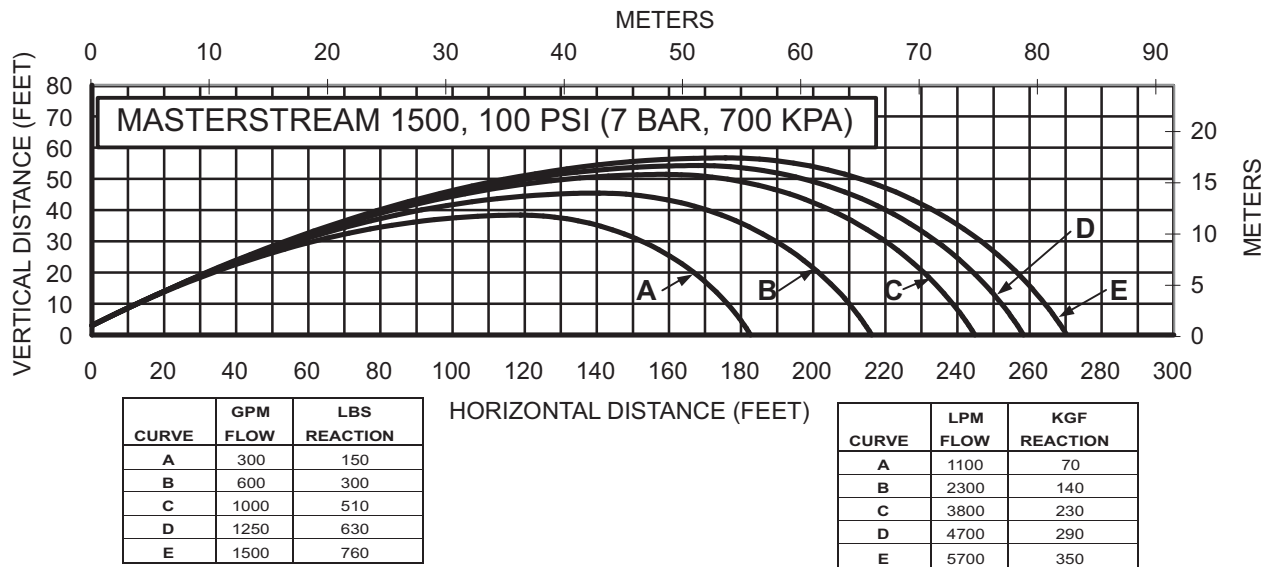
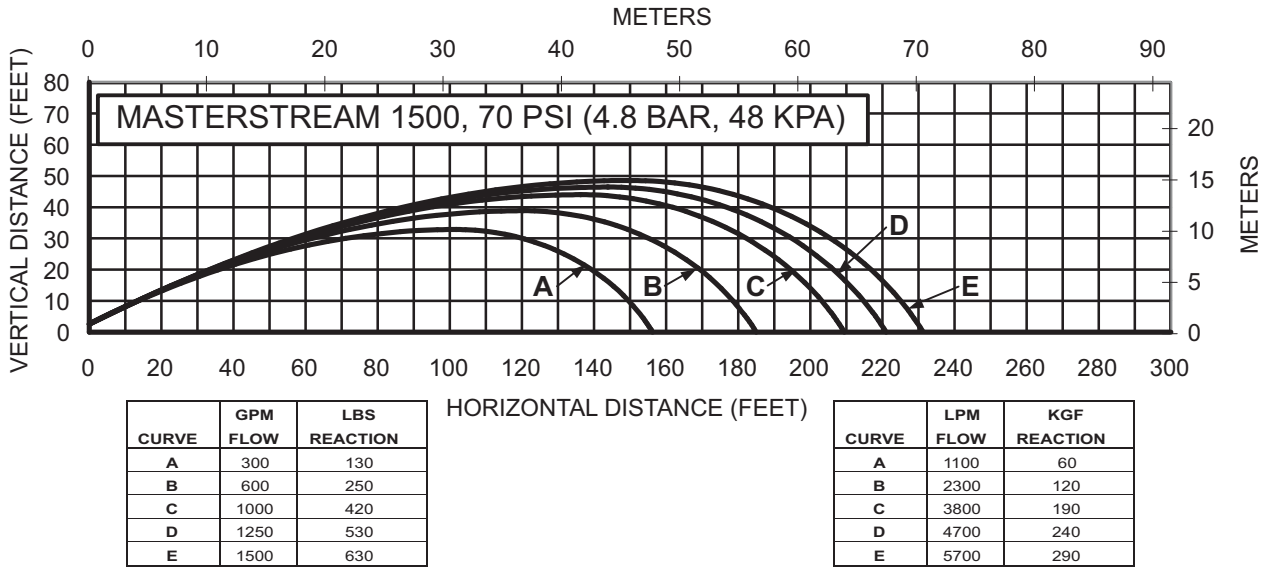

FIG 4C - Masterstream 1500 Stream Trajectory

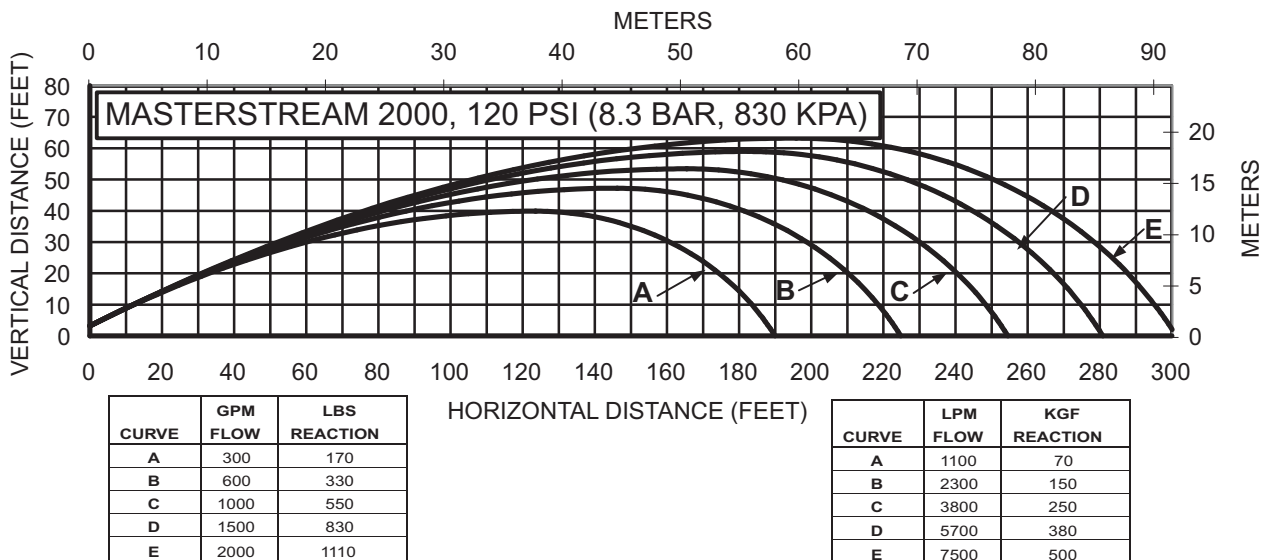
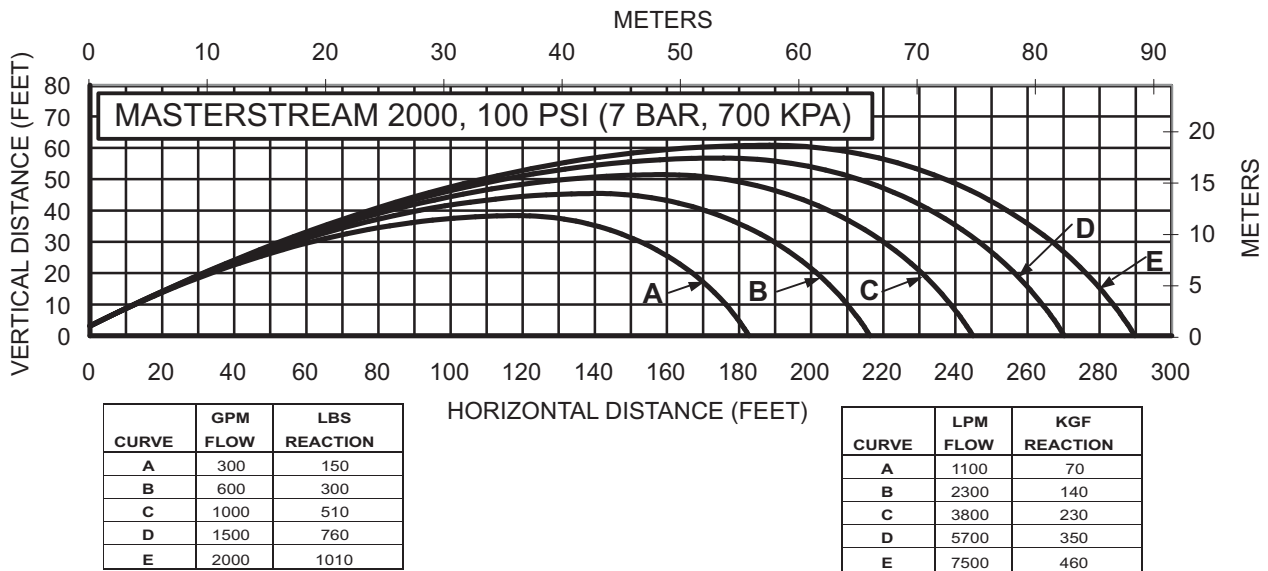
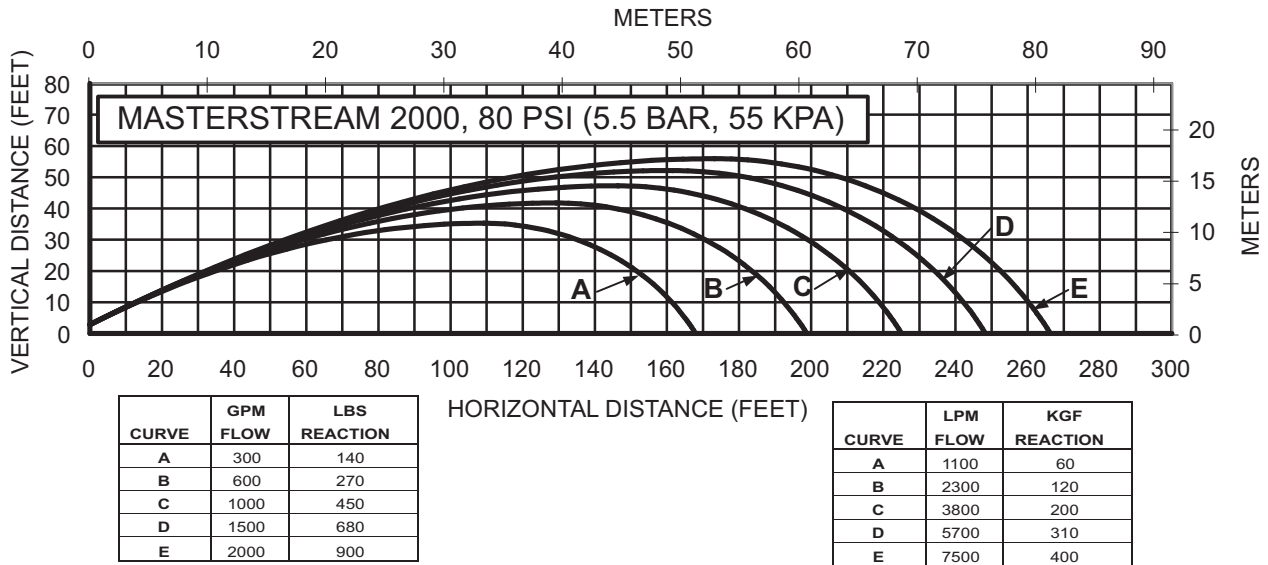

FIG 4D - Masterstream 2000 Stream Trajectory

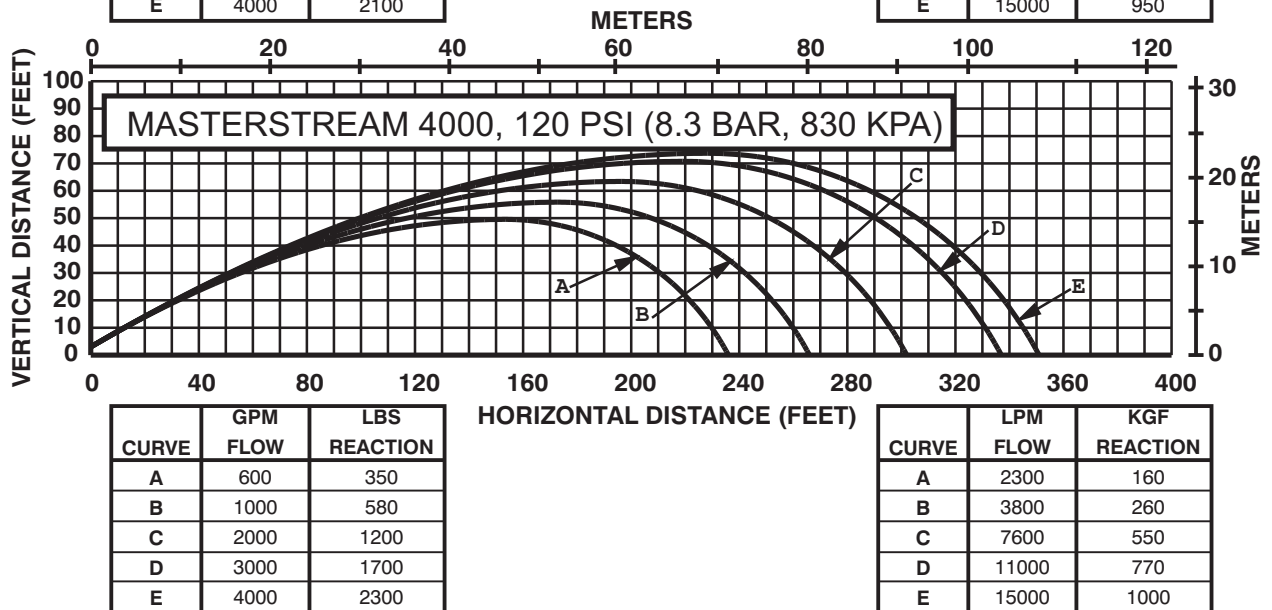
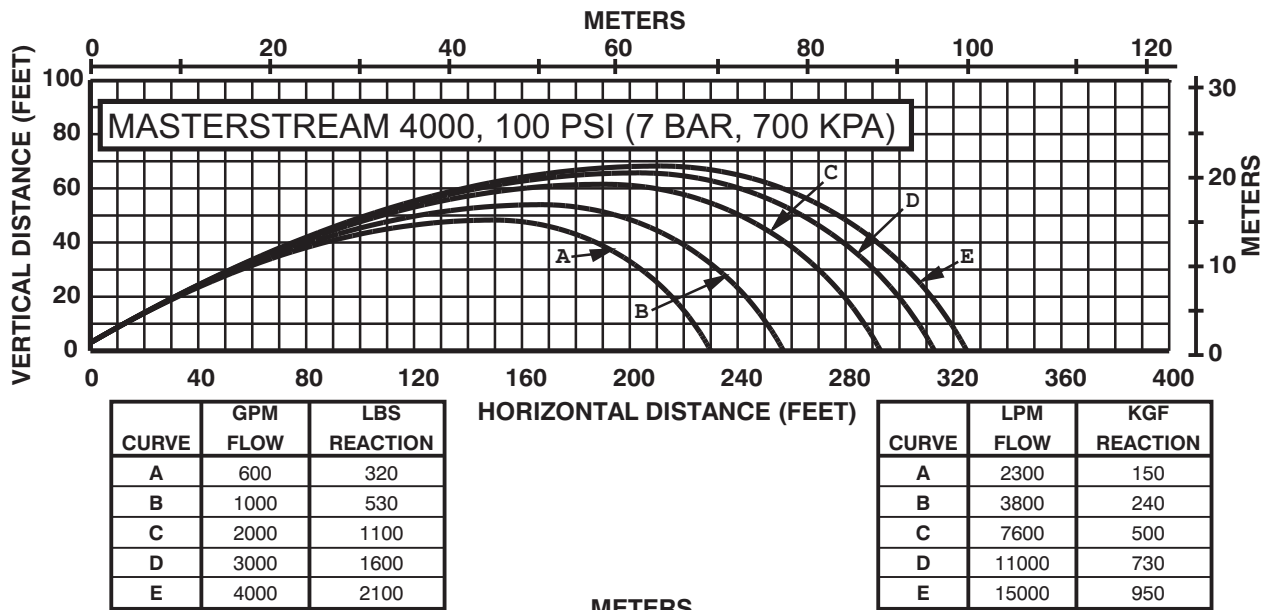
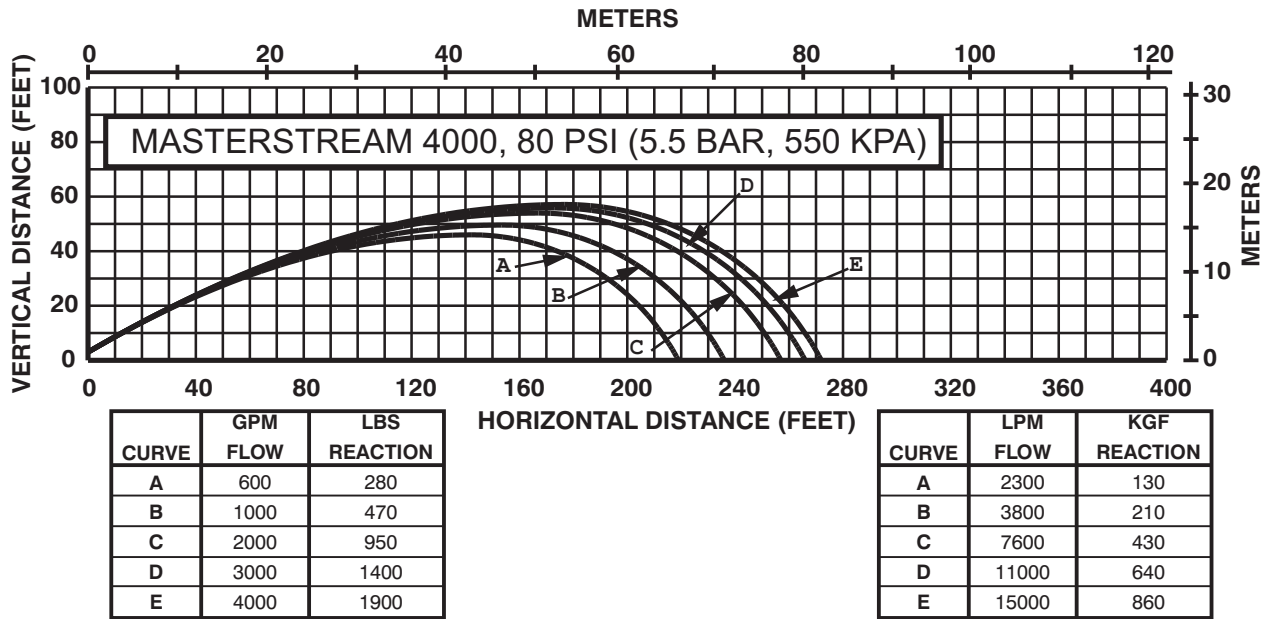

FIG 4E - Masterstream 4000 Trajectory

4.0 FLUSHING DEBRIS

Debris in the water may get caught inside the nozzle. This trapped material will cause poor stream quality, shortened reach and reduced flow. To remove debris trapped in the nozzle:

1. Shut off flow to the nozzle.
2. Move the stream shaper to the wide fog position.
3. Carefully unscrew and remove the nozzle's piston/cylinder.

Notes on Masterstream 1000 Nozzle:

- The cylinder is under about 25 lbs (11Kgf) of spring force. The spring must be compressed to reinstall.
- A long white push rod is part of the cylinder assembly. Pull cylinder straight out until push rod clears shaft.

Notes for Masterstream 1250, 1500, 2000 and 4000 Nozzles:

- Remove the piston, return spring and cylinder
- Remove the small spring and stainless steel poppet from the center of the shaft as a unit.

4. Remove debris.
5. Reassemble the nozzle.

Figures 5A, 5B, 5C & 5D show the pieces that are removed during the flush procedure.

WARNING Large amounts of debris may be unflushable and can reduce the flow of the nozzle resulting in an ineffective flow. In the event of a blockage, it may be necessary to retreat to a safe area.

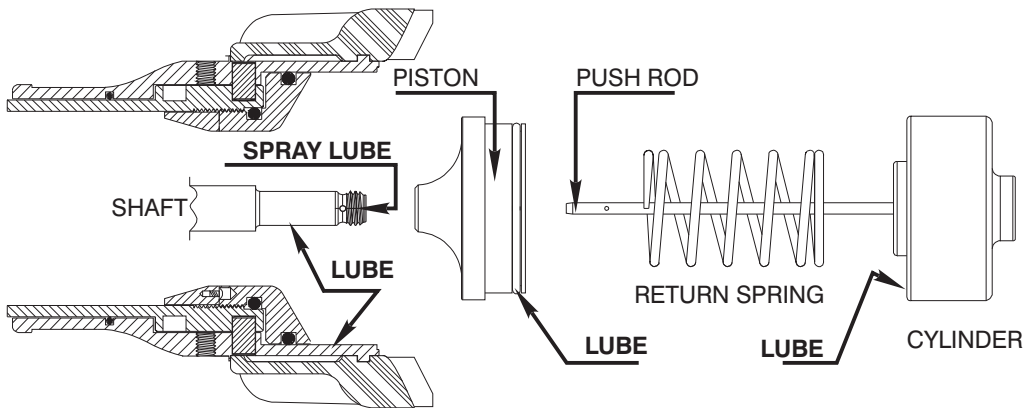

FIG 5A - Masterstream 1000 Front End Parts

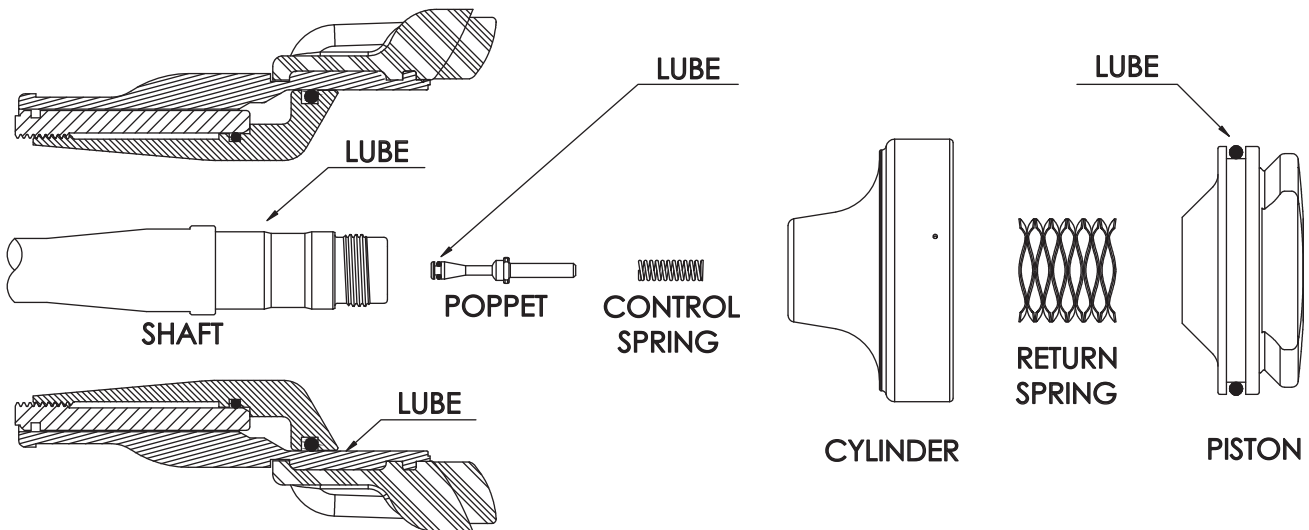

FIG 5B - Masterstream 1250 and 1500 Front End Parts

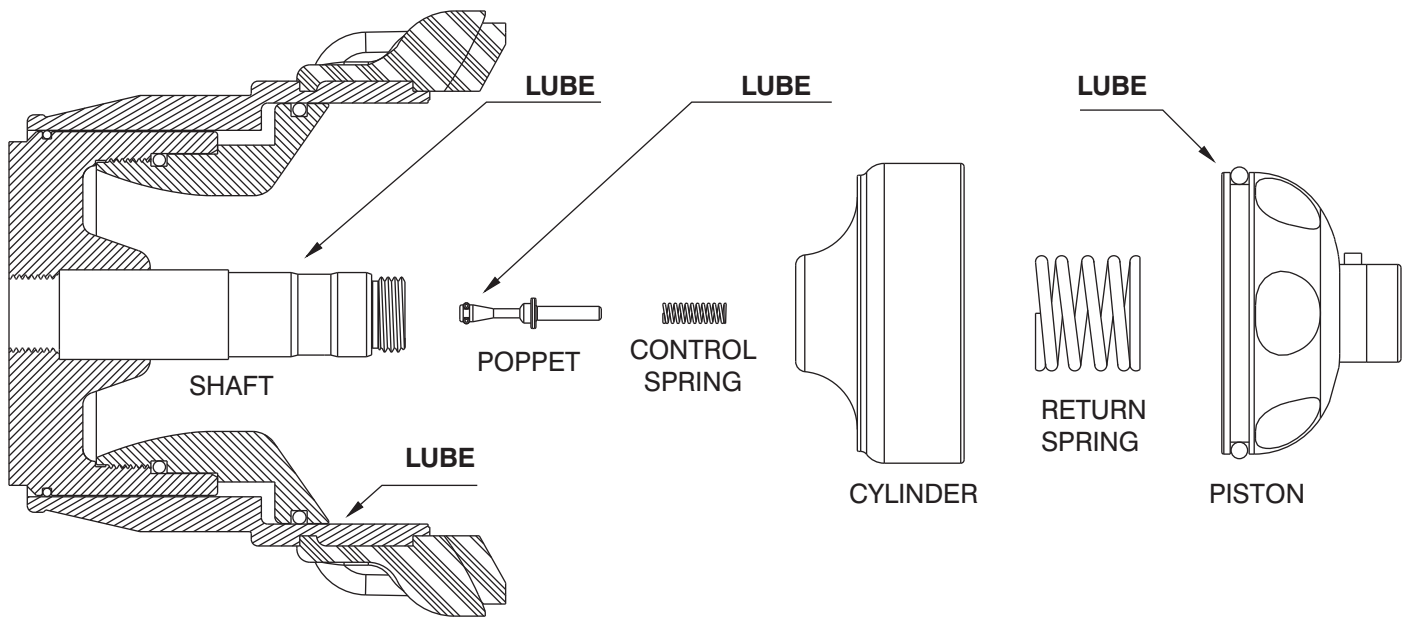

FIG 5C - Masterstream 2000 Nozzle Front End Parts

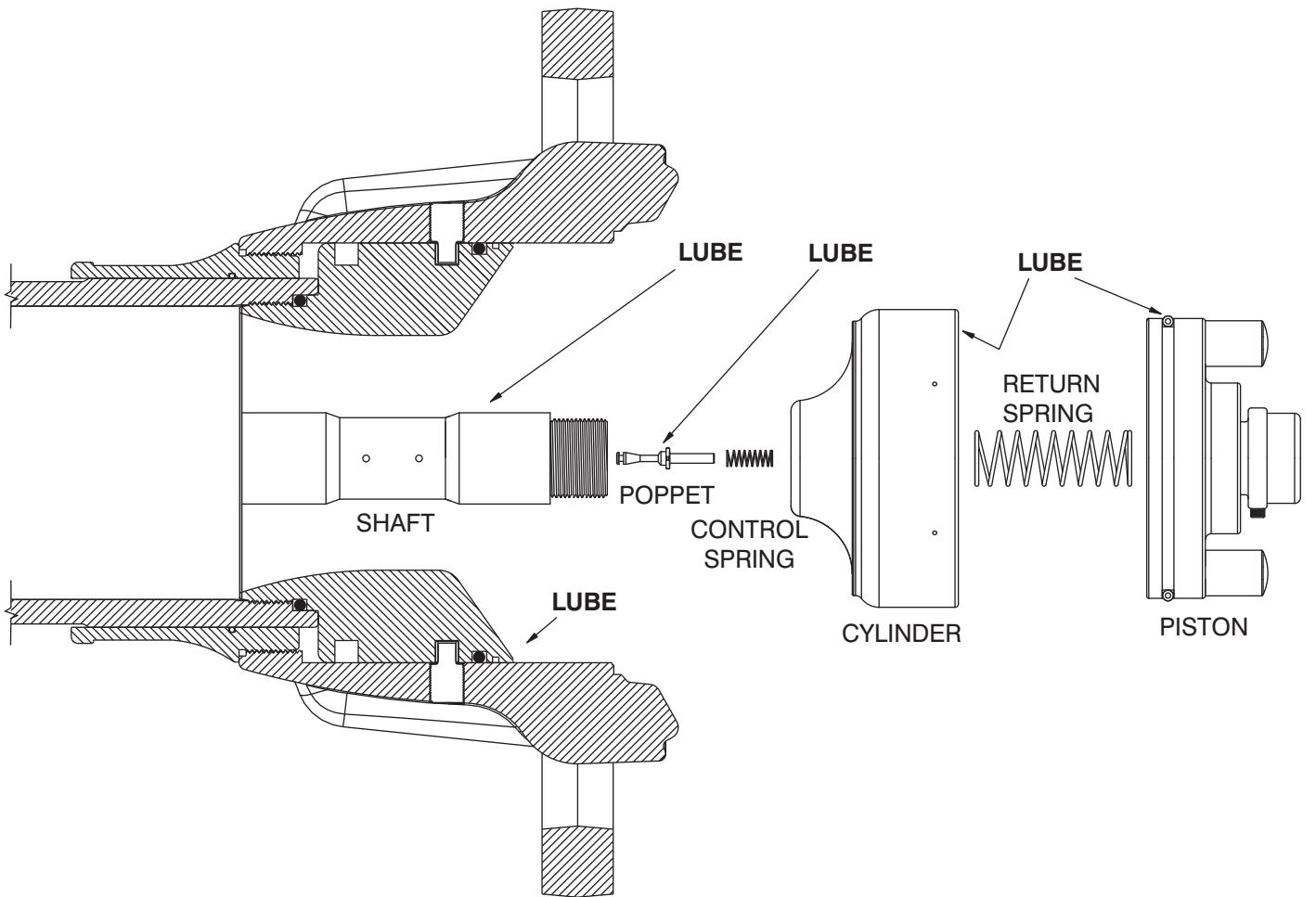

FIG 5D - Masterstream 4000 Nozzle Front End Parts

5.0 MAINTENANCE

When reassembling the nozzle after repairs or for preventive maintenance, coat the seal on the piston, the inner bore of the cylinder and the shaft slide surface with a waterproof lubricant such as Dow Corning #112 Silicone Grease. Lubrication is required to assure continued smooth operation. The frequency of lubrication will depend on frequency of usage and storage conditions. Nozzles must be checked regularly to assure proper operation. See figures 5A, 5B and 5C for the nozzle lubrication points.

STORAGE: Store the Masterstream 4000 Hydraulic Nozzle in the Full Fog (retracted) position.

Contact factory for parts lists and exploded views for particular models. Each nozzle is identified by a serial number located on the nozzle's stream shaper (see figure 1).

6.0 WARRANTY

Task Force Tips, Inc., 2800 East Evans Avenue, Valparaiso, Indiana 46383-6940 ("TFT") warrants to the original purchaser of its Masterstream Series nozzles ("equipment"), and to anyone to whom it is transferred, that the equipment shall be free from defects in material and workmanship during the five (5) year period from the date of purchase.

TFT's obligation under this warranty is specifically limited to replacing or repairing the equipment (or its parts) which are shown by TFT's examination to be in a defective condition attributable to TFT. To qualify for this limited warranty, the claimant must return the equipment to TFT, at 2800 East Evans Avenue, Valparaiso, Indiana 46383-6940, within a reasonable time after discovery of the defect. TFT will examine the equipment. If TFT determines that there is a defect attributable to it, TFT will correct the problem within a reasonable time. If the equipment is covered by this limited warranty, TFT will assume the expenses of repair.

If any defect attributable to TFT under this limited warranty cannot be reasonably cured by repair or replacement, TFT may elect to refund the purchase price of the equipment, less reasonable depreciation, in complete discharge of its obligations under this limited warranty. If TFT makes this election, claimant shall return the equipment to TFT free and clear of any liens and encumbrances.

This is a limited warranty. The original purchaser of the equipment, any person to whom it is transferred, and any person who is an intended or unintended beneficiary of the equipment, shall not be entitled to recover from TFT any consequential or incidental damages for injury to person and/or property resulting from any defective equipment manufactured or assembled by TFT. It is agreed and understood that the price stated for the equipment is in part consideration for limiting TFT's liability. Some states do not allow the exclusion or limitation of incidental or consequential damages, so the above may not apply to you.

TFT shall have no obligation under this limited warranty if the equipment is, or has been, misused or neglected (including failure to provide reasonable maintenance) or if there have been accidents to the equipment or if it has been repaired or altered by someone else.

THIS IS A LIMITED EXPRESS WARRANTY ONLY. TFT EXPRESSLY DISCLAIMS WITH RESPECT TO THE EQUIPMENT ALL IMPLIED WARRANTIES OF MERCHANTABILITY AND ALL IMPLIED WARRANTIES OF FITNESS FOR A PARTICULAR PURPOSE. THERE IS NO WARRANTY OF ANY NATURE MADE BY TFT BEYOND THAT STATED IN THIS DOCUMENT.

This limited warranty gives you specific legal rights, and you may also have other rights which vary from state to state.

TASK FORCE TIPS, Inc.
MADE IN USA • www.tft.com

2800 E. Evans Ave, Valparaiso, IN 46383-6940 USA
800-348-2686 • 219-462-6161 • Fax 219-464-7155