

Instruction: Folding Pistol Grip Installation

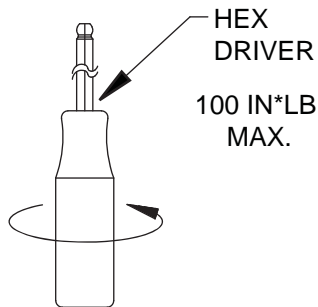

- 1) Remove existing grip from valve body by inserting a 5/16" hex ball end driver into the bottom of the grip and unscrew the mounting bolt. If adding a pistol grip to a nozzle remove the set screw from the bottom side of the valve body.
- 2) Remove the mounting bolt, washer, grip, and spacer.
- 3) Insert new 3/8-16 X 1.75 bolt into new grip. If bolt won't go in, then align cross pin hole with hole in grip using a screwdriver or pick. Cross pin must not be pushed sideways out of the pistol grip. (Reinserting the cross pin requires special tools.)
- 4) Place the spacer on top of the new grip so that the bolt protrudes through the hole in that as well.
- 5) Apply Loctite # 271 to cover first five threads of mounting bolt.
- 6) Align bolt with threads in nozzle body and turn screw two full turns. The grip will need to be slightly turned for proper bolt alignment (as shown below).

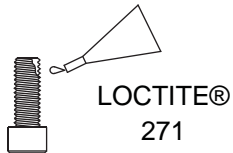
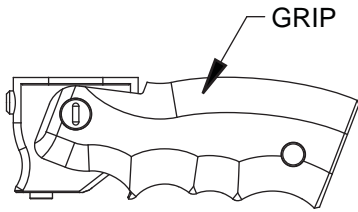

- 7) Turn the grip to align with nozzle body. (as shown below).



- 8) Tighten the mounting bolt to a maximum torque of 100 in*lbs. Allow the loc-tite to cure for 24 hours prior to normal use.

CAUTION

Do not fold grip unless it is installed on a nozzle. Spring loaded base can pinch fingers before assembly is complete.

Instruction: Folding Pistol Grip Installation

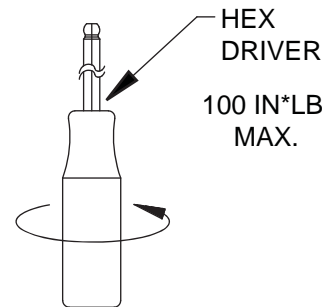
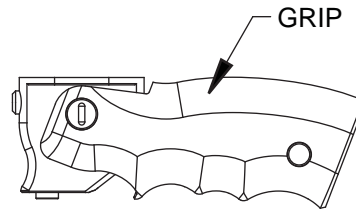
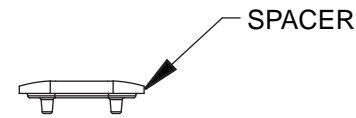

- 1) Remove existing grip from valve body by inserting a 5/16" hex ball end driver into the bottom of the grip and unscrew the mounting bolt. If adding a pistol grip to a nozzle remove the set screw from the bottom side of the valve body.
- 2) Remove the mounting bolt, washer, grip, and spacer.
- 3) Insert new 3/8-16 X 1.75 bolt into new grip. If bolt won't go in, then align cross pin hole with hole in grip using a screwdriver or pick. Cross pin must not be pushed sideways out of the pistol grip. (Reinserting the cross pin requires special tools.)
- 4) Place the spacer on top of the new grip so that the bolt protrudes through the hole in that as well.
- 5) Apply Loctite # 271 to cover first five threads of mounting bolt.
- 6) Align bolt with threads in nozzle body and turn screw two full turns. The grip will need to be slightly turned for proper bolt alignment (as shown below).



- 7) Turn the grip to align with nozzle body. (as shown below).



- 8) Tighten the mounting bolt to a maximum torque of 100 in*lbs. Allow the loc-tite to cure for 24 hours prior to normal use.

CAUTION

Do not fold grip unless it is installed on a nozzle. Spring loaded base can pinch fingers before assembly is complete.



Pistol Grip Replacement Kit Spacer Identification

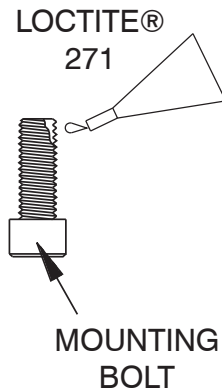
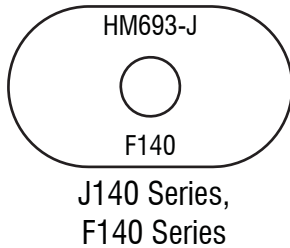
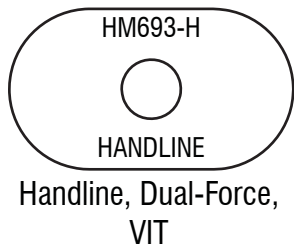
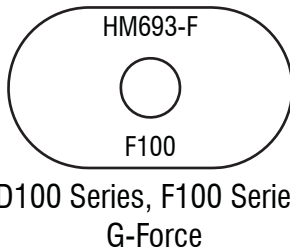
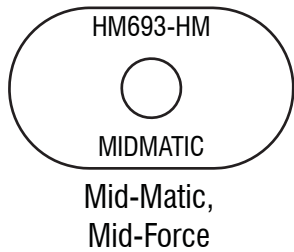
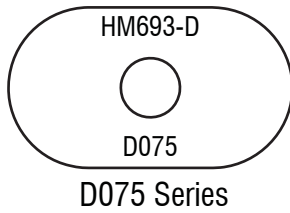
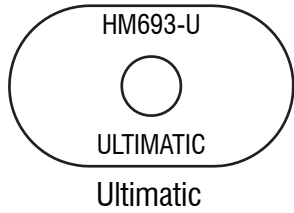

Pistol Grip Replacement Kit Spacer Identification

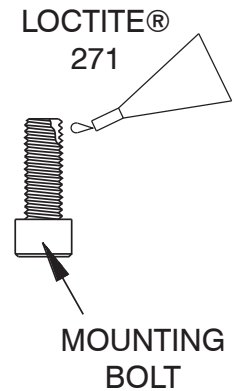
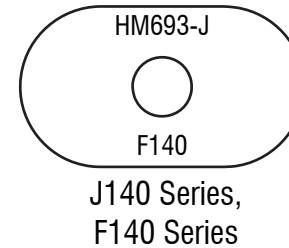
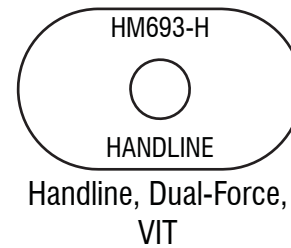
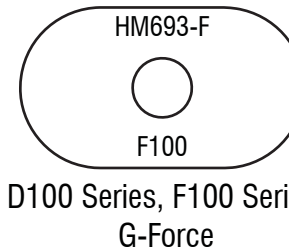
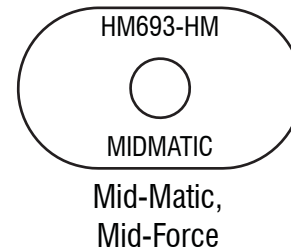
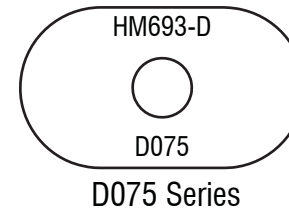
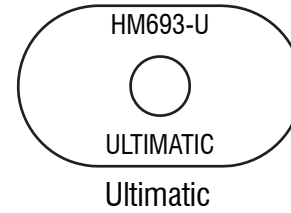

This Kit will not fit if:

Your Ultimatic, Midmatic, Mid-Force, Handline or Dual-Force nozzle has a pistol grip that looks like this or has a serial number lower than TFT*-325000.

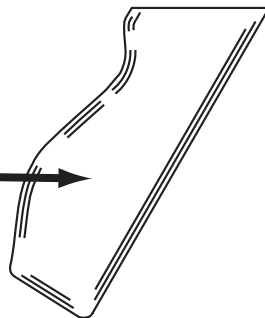

This Kit will not fit if:

Your Ultimatic, Midmatic, Mid-Force, Handline or Dual-Force nozzle has a pistol grip that looks like this or has a serial number lower than TFT*-325000.

